

Overview

- 2MP (1920*1080)
- WDR 120dB
- 2.8-12mm Lens
- H.265, H.264, MJPEG
- IR, IP67, IK10 Rated
- Build in Mic







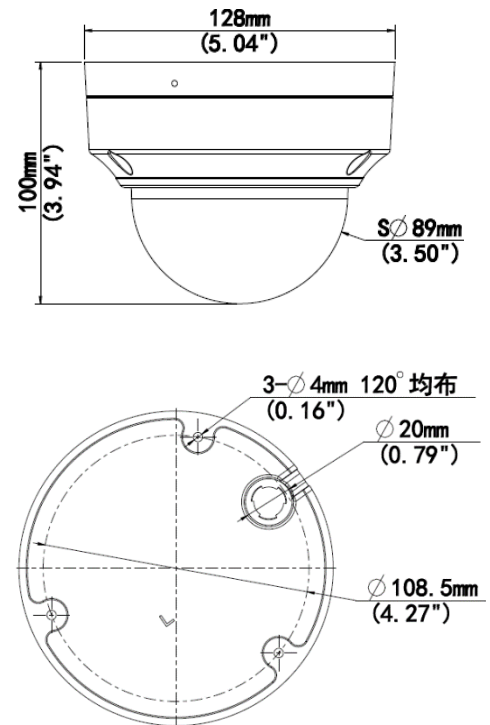











Technical Specifications

Device	
Image Sensor:	1 / 2.7" Progressive Scan CMOS
Min Illumination:	Color: 0.005Lux (F1.6, AGC ON) 0Lux with IR
Shutter Time:	Auto/Manual, 1 ~ 1/100000s
Lens:	2.8 ~ 12mm, AF automatic focusing and motorized zoom lens
WDR:	120 dB
Angle of View:	H: 108.05°, V: 58.81°
Angle Adjustment:	Pan: 3° ~ 360° Tilt: 0° ~ 70°
Day & Night:	IR-Cut Filter with Auto Switch (ICR)
IR Range:	Up to 40m (131ft) IR range
Compression Standard	
Video Compression:	H.265, H.264, MJPEG
Video Bit Rate:	128 Kbps~6 Mbps
Two Stream:	Yes
Analytics:	Cross line, intrusion (based on human body detection) motion detection, tampering alarm, audio detection
Image	
Max. Image Resolution:	1920 x 1080
Frame Rate:	30fps (1920 x 1080)
ROI Codec:	Up to 8 areas
Image Setting:	White Balance, Digital Noise Reduction, Smart IR, Flip, HLC, BLC



Technical Specifications

Network							
Protocols:	IPv4, IGMP, ICMP, ARP, TCP, UDP, DHCP, RTP, RTSP, RTCP, RTMP, DNS, DDNS, NTP, UPnP, HTTP, HTTPS, SMTP, SSL/TLS, QoS, SNMP						
Interface							
Communication Interface:	10M/100M Base-TX Ethernet						
Storage							
Edge Storage	Micro SD, up to 128GB						
General							
Safety	CE: EN 60950-1 UL: UL60950-1 IEC 60950-1						
EMC	FCC: FCC Part 15						
Operating Conditions:	Temperature: -30°C~60°C (-22°F~140°F), Humidity: ≤95%RH (Non-Condensing)						
Power Consumption:	Max 7.5 W						
Power Supply:	DC 12V±25%, PoE (IEEE 802.3af)						
Weatherproof Rating:	IP67						
Vandal Resistant:	IK10						
Dimensions:	Ø128mm x 100mm (Ø5.04" x 3.94")						
Net Weight:	0.75kg						
Software:	No license required for use with Video Insight Software						
Optional Accessories	<table border="0"> <tr> <td style="text-align: center;"> <p>M-JB-T</p>  </td> <td style="text-align: center;"> <p>M-WM-T</p>  </td> <td style="text-align: center;"> <p>M-PM</p>  </td> </tr> <tr> <td style="text-align: center;"> <p>M-NPT34</p>  </td> <td style="text-align: center;"> <p>M-Pendant</p>  </td> <td style="text-align: center;"> <p>M-Pendant-Ex</p>  </td> </tr> </table>	<p>M-JB-T</p> 	<p>M-WM-T</p> 	<p>M-PM</p> 	<p>M-NPT34</p> 	<p>M-Pendant</p> 	<p>M-Pendant-Ex</p> 
<p>M-JB-T</p> 	<p>M-WM-T</p> 	<p>M-PM</p> 					
<p>M-NPT34</p> 	<p>M-Pendant</p> 	<p>M-Pendant-Ex</p> 